

Aluminum Wood End Showcases

The classic beauty of Stylmark's anodized aluminum extrusions provides a subtle accent to finely crafted woods and laminates. Components are first fabricated and then finished and anodized. This assures that all reflectors, cover tees, glass channels, door hardware, brackets and standards match perfectly. Wood end showcase components are sold fabricated or in stock lengths for field fabrication.

Typical Showcase Components

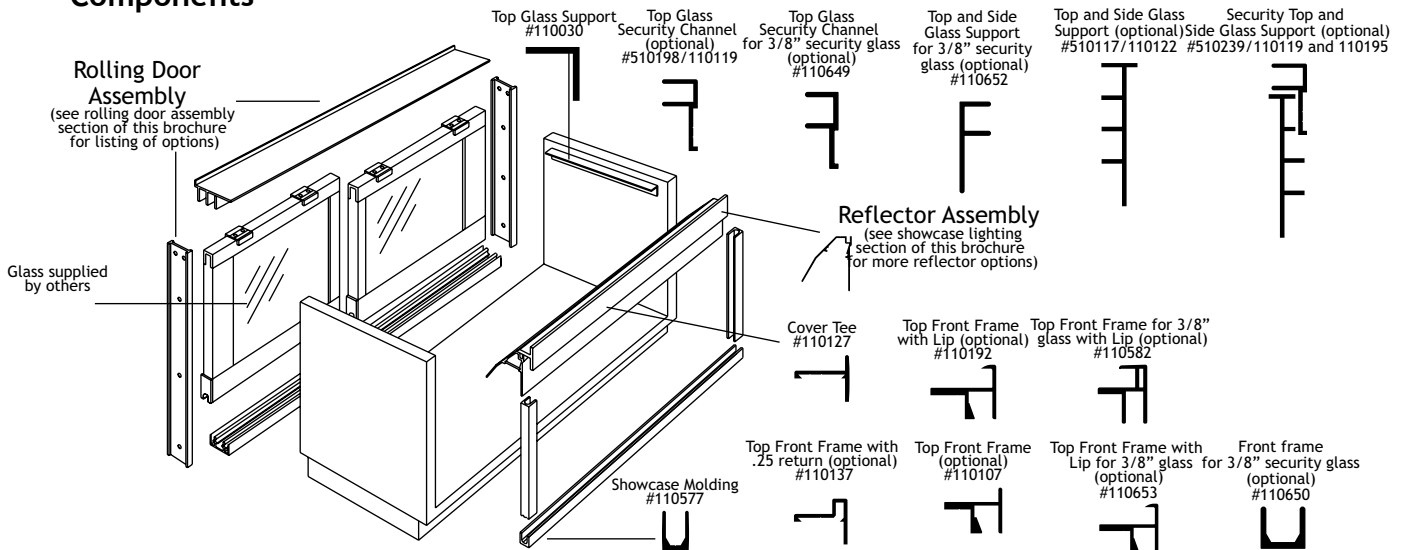

Showcase Components Typical Vertical Section

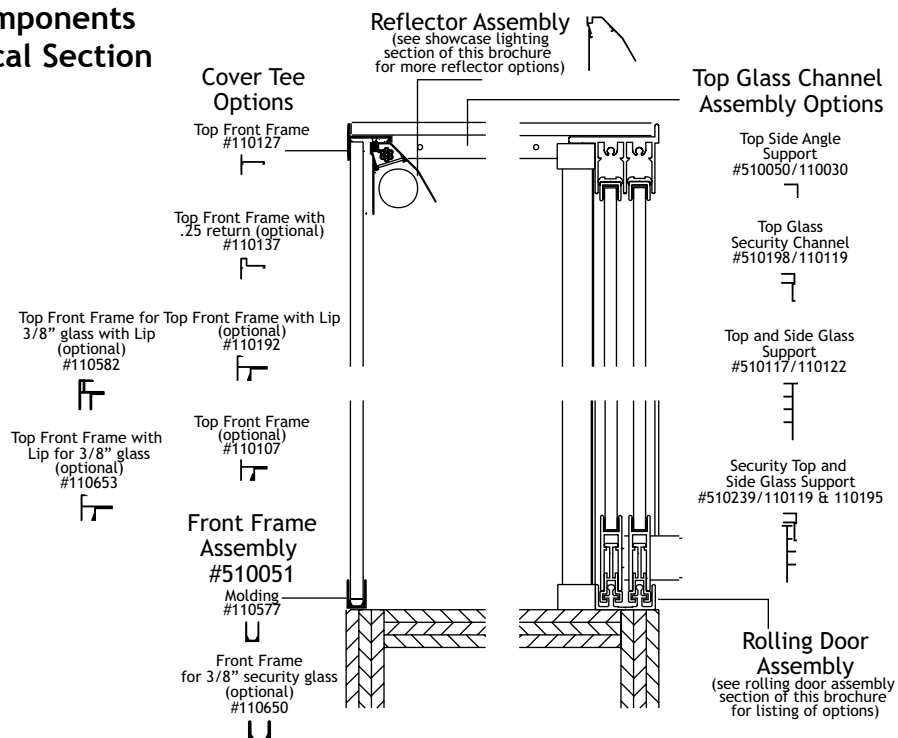

Aluminum Wood End Showcases

ORDERING WOOD END SHOWCASES			
REFLECTOR ASSEMBLY	ROLLING DOOR ASSEMBLY	FRONT GLASS FRAME ASSEMBLY	TOP GLASS CHANNEL ASSEMBLY
SEE PAGE 20	SEE PAGE 44	WIDTH x HEIGHT	DEPTH

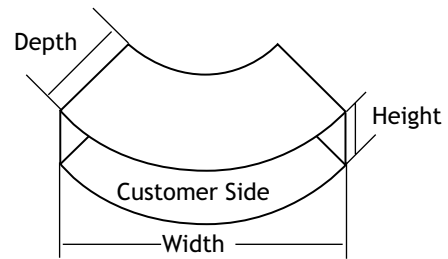
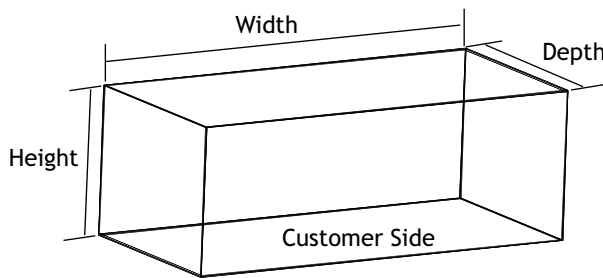

Rectangular or Curved

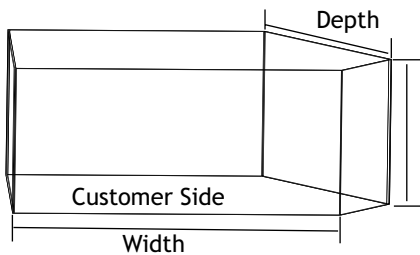

LH Clipped

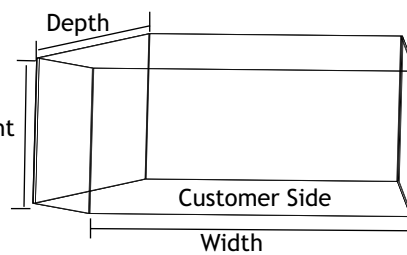

RH Clipped

Right or Left Hand Clipped

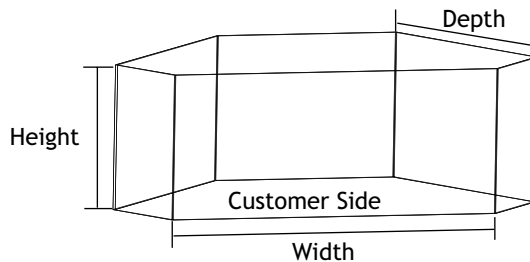

Double Clipped

- Notes:**
- When ordering clipped, curved, or custom showcases, please provide shop drawings.
 - Slotted standards and brackets are ordered separately (see page 19).

Aluminum Wood End Showcases

Choose from the options below to customize a showcase to your exact specifications.

Front Frame Options

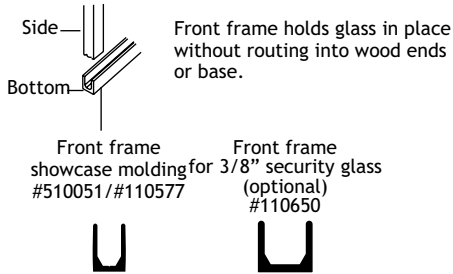

Rolling Door Assemblies

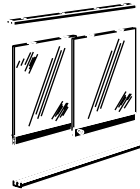

See the rolling door section of this brochure for full configuration details.

Cover Tee Options

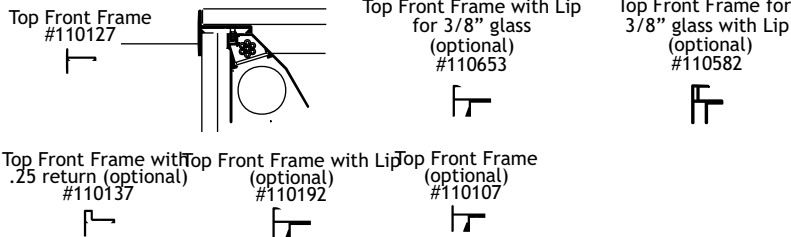

*Some reflectors come with an integrated cover tee - see assemblies below.

Top and Side Glass Channel Assemblies

Top and side glass supports require no routing of wood ends or base to install. Glass supports give you the option to provide security.

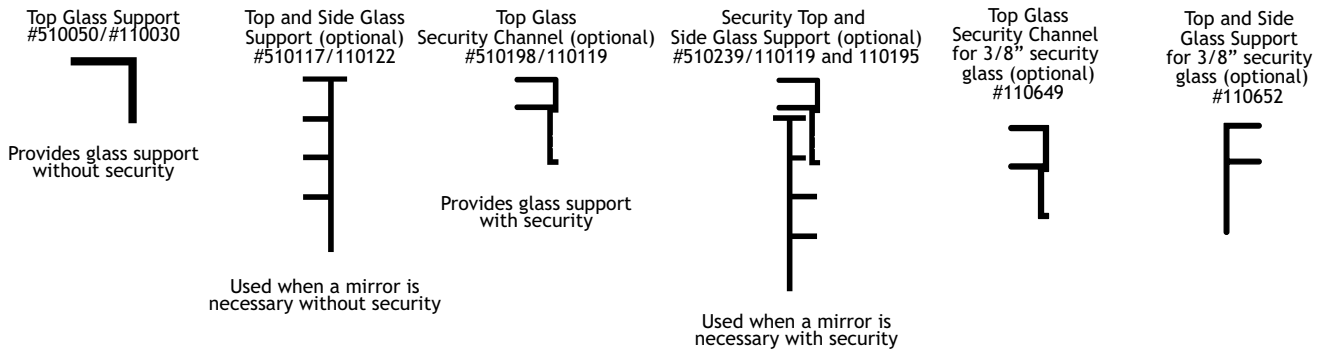

Reflector Assemblies

Flourescent & halogen reflector assemblies are shipped completely fabricated and assembled, flourescent lamps not included. Halogen reflectors have lamps provided by Stylmark. LED reflectors include LED lighting modules. See page 20 of this brochure for lighting details.

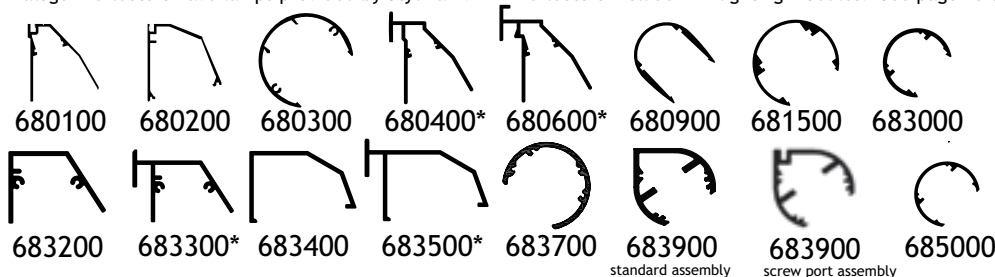

Notes: *Indicates integrated cover tee reflectors.

Aluminum Wood End Showcases

Hardware and Accessories

Part #110030
1/2" Angle

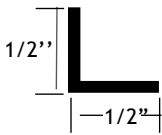

Part #110106
Mullion

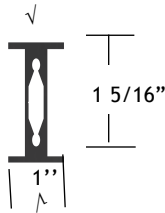

Part #110107
Front Frame

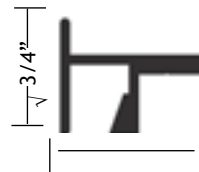

Part #110119
Security Channel

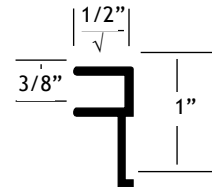

Part #110122
Top and Side
Glass Support

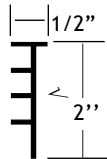

Part #110127
Top Front Frame

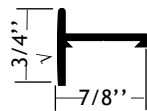

Part #110137
Cover T with
.25 Return

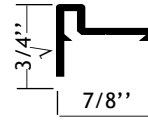

Part #110192
Front Frame
with Lip
#110653 for 3/8" glass

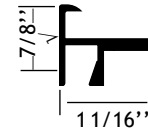

Part #110195
Security Top and
Side Glass Support

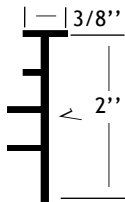

Part #110523
Backframe Header
without Top Glass

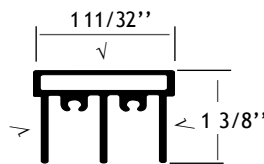

Part #110577
Showcase Molding
without holes
(with holes #410099)

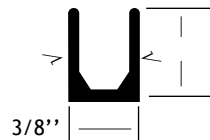

Part #110582
Showcase Rail

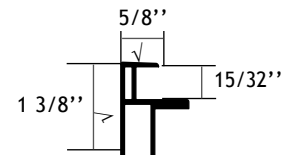

Part #110640
Backframe Header
without Top Glass
for 1/2" glass

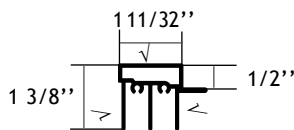

Part #110657
Backframe Vertical

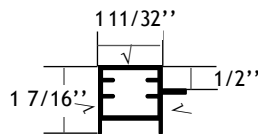

Part #119029
Vinyl Bumper



Part #232006

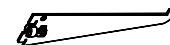

Notes: • With the exception of reflector assemblies, wood end showcase components can be ordered in stock lengths for customer fabrication.

√ = finished surface

Aluminum Wood End Showcases

Hardware and Accessories

Part #232023
Slotted Steel Standard,
36''
(96'' #232028)



Part #450010
Slotted Standard

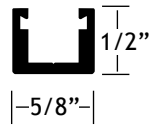

Part #450020
Heavy Duty
Slotted Standard



Part #450021
Rear Support for
#450020



Part #450022
Rear Support
for #450010



Part #510089
Mounting Bracket
Assembly for
110107/110192

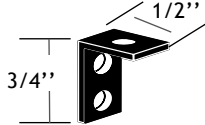

Part #550007
Foot and Cap
Assembly for
Aluminum Standard

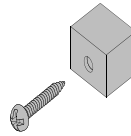

Part #550008
Chrome Bottom Cap
Assembly for Steel
Standard

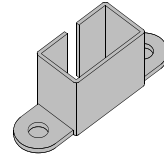

Part #550009
Chrome Top Cap
Assembly for
Steel Standard

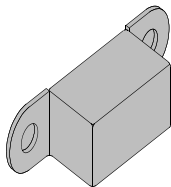

Part #550011
Shelf End Clip
for 550010

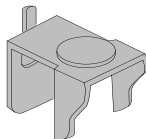

Part #550012
Shelf Center
Clip for 550010

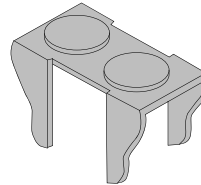

Part #550013
Glass End Clip
for 550006

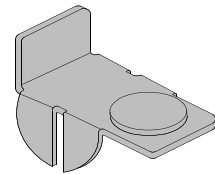

Part #550014
Glass Center Clip
for 550006

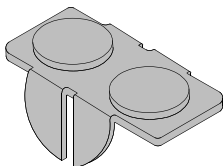

Part #550006
Aluminum Shelf Blade Bracket
with and without lip
Available in
6, 8, 10, 12, 14, 16''

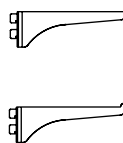

Part #550010
Aluminum Tubular
Shelf Bracket
Available in
6, 8, 10, 12, 14, 16''

