

Mirror Frames

Stylmark’s mirror frames allow for easy assembly, glazing and installation on-site. When placed in the mounting bracket, the installed mirrors are theft-proof. Mirror frame components are sold in 12’ stock lengths or material may be fabricated to meet your specific requirements.

ORDERING MIRROR FRAMES		
MODEL #	DESCRIPTION	DIMENSIONS: WIDTH x HEIGHT
620062	MIRROR FRAME	PROVIDE MIRROR OR FRAME DIMENSIONS

Part #620062 Mirror Frame Assembly

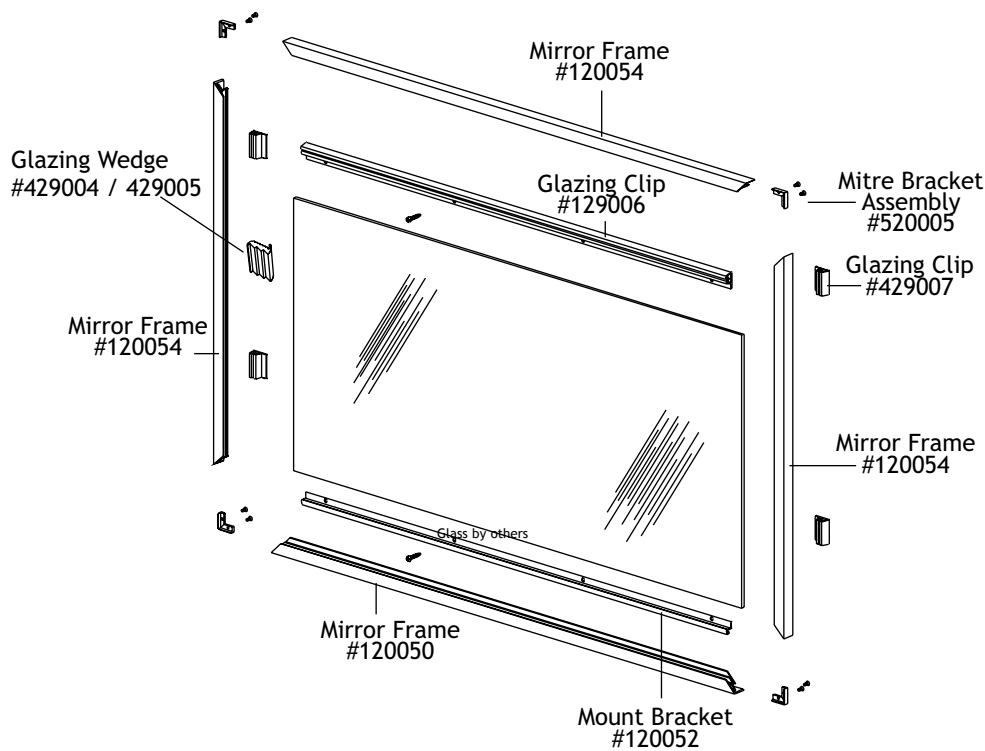

- Notes:**
- Frame size min / max dimensions are 10” x 144”
 - Mirror sizes will be provided on order acknowledgement from Stylmark
 - Mirror frame materials can be ordered in 12 foot lengths for customer fabrication

Mirror Frames

Part #120050
Mirror Frame - Bottom

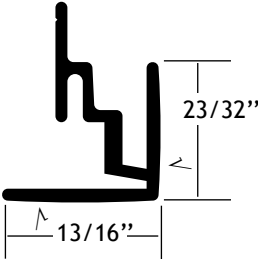

Part #120052
Mount Bracket

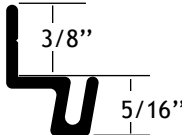

Part #110167
Angle Mount Bracket

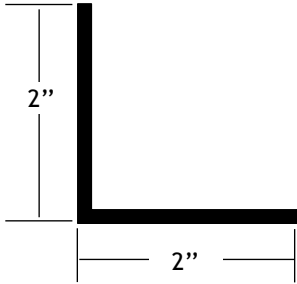

Part #120054
Mirror Frame

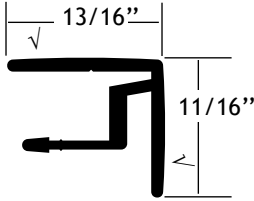

Part #129006 (12 ft)
Part #429007 (1 1/2ft)
Plastic Glazing Clip



Part #429004: 1/4" Glazing Wedge
Part #429005: 3/16" Glazing Wedge

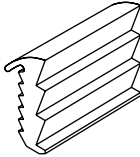

Part #520005
Mitre Bracket Assembly

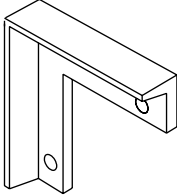

= finished surface